

1.27mm Latching Pin Headers

Single Row Right Angle with Fixing Pin

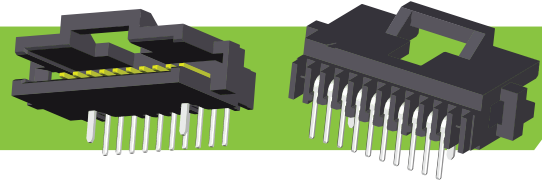

PRODUCT DETAILS

The Flex Connection range of 1.27mm Shrouded and Unshrouded Board Mounted PCB connectors provide a reliable high density interconnect system. We offer the widest range of product available on the market with single row and double row products with and without shroud and also in thru hole and SMD versions. Options for the shrouded connectors includes Right Angle, Vertical, Thru Hole, SMD in both Vertical and Right Angle with or without Fixing Pins. Product is supplied as standard with Gold plating in the contact area. These connectors are ideal to use to mate with high density 1.27mm connectors on Flexible Cables, Flexible Circuits and Membrane Switches.

FEATURES

 Quality Design

 Cost-Effective

MATING CONNECTOR

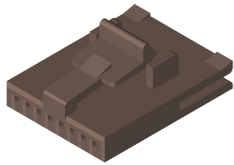

MH545

DIMENSION OUTLINE

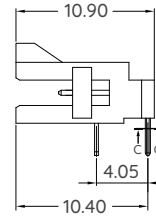
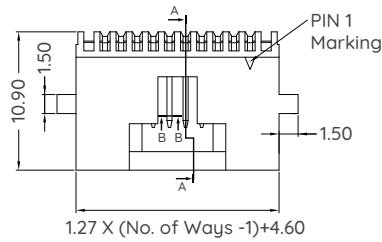

Recommended P.C.B Layout (Top Side) (PCB BOARD TOLERANCE ± 0.05)

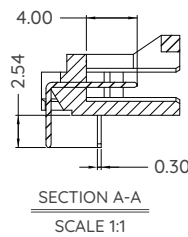
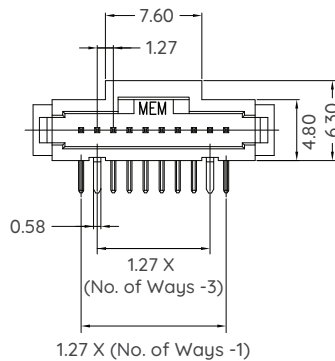
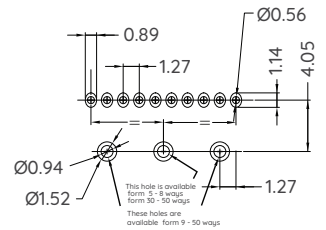

ELECTRICAL AND MECHANICAL PROPERTIES

Pitch	1.27mm
Contact Pin	0.40mm Square
Insulator Material	PA9T + 30% GF UL 94V-O
Mating Housing	MH545 Latching Housing
Number of Ways	4 to 50 ways
Contact Material	Phosphor Bronze
Contact Area Plating	Gold over Nickle
Solder Pins Plating	Tin Plated over Nickle
Current Rating	2A AC, DC
Contact Resistance	>20m Ω
Rated Voltage	300 VRMS
Withstanding Voltage	900 VRMS
Breakdown Voltage	1200 VRMS
Insulation Resistance	1000 MΩ @ 500VRMS
Operating Temperatre Range	-40 Deg C to + 125 Deg C
Insulation Resistance	1000 MΩ
Mechanical Endurance	500 Operations
Forces	Mating: 2N/Contact Max Unmating: 0.2N/Contact Min

PART NUMBERING BREAKDOWN

